

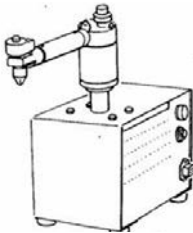

Vaihinger GmbH  
Horstweg 29  
65520 Bad Camberg-Erbach  
Telephone 0049 (6434) 9405-0  
Telefax 0049 (6434) 9405-99  
<http://www.sanomat.com>  
[info@vaihinger.com](mailto:info@vaihinger.com)

**Mini-Bako-S with stand**

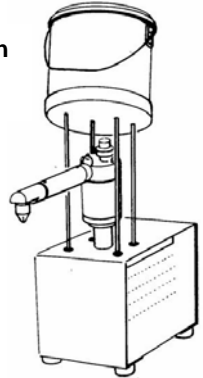

**Mini-Bako-S-GPM**

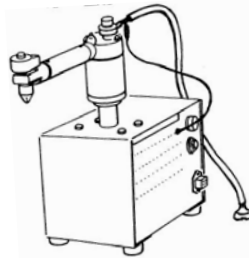

**Mini-Bako-S-GPMA**

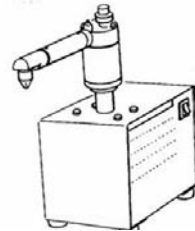

**Mini-Bako-S**

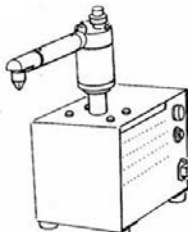

**Mini-Bako-S-GP**

**SANOMAT**

Cream machine  
**SANOMAT-Mini-Bako-S(-GP/-GPM/-GPMA)**  
**(-top part with Stand)**

230V/50Hz  
110-120V/60Hz  
100V/50/60Hz

**Operating instructions**



---

## The correct handling of cream and your SANOMAT

You are a proud owner of an efficient, energy saving cream whipping machine. To achieve the very best results we suggest the following:

Cream is a natural product that varies with the season such as forage mixtures for the dairy cows. This can have an effect on the quality of the cream and therefore have an influence on whipping volume and stability.

Basically we suggest using fresh cream with a temperature between +3° to +5°C and with a fat content between 30 % and 36 %. If you would like to use homogenised cream we recommend products of namable producers because other products often breed to a dissatisfying result.

Please note:

**The cold chain from the dairy to you must absolutely be kept, because just a short warming can perish the cream culture and could make a whipping impossible.**

To avoid a contamination with bacteria carry out the daily disinfection cleaning after closing hour and also the regular cleaning of air regulation. (to find from side 13 on)

On the following sides we lead you step by step through the right exposure with your new SANOMAT.

Your Vaihinger Team



## *Index*

Unpacking and checking .....	5
Use according to determination of SANOMAT .....	5
Safety first! .....	6
Setting-up and connecting.....	7
Getting ready to start unit .....	8
Setting whipped cream consistency .....	10
Selecting desired quantity of whipped cream .....	11
Cleaning and maintenance (Overview).....	12
Daily disinfection cleaning .....	13
Monthly cleaning of air regulation .....	16
Thorough cleaning and technical check-up .....	17
<b>Garnishing Pistol and Foot Switch (GP) .....</b>	<b>21</b>
Troubleshooting .....	24
Shipping information .....	25
Disposal instructions.....	25
Technical data .....	25
Spare parts Mini-Bako-S/-GP/-GPM.....	26
Order numbers .....	27
Spare parts top part.....	28
Order numbers .....	29
Spare Parts and Order numbers GPMA.....	29
Declaration of conformity.....	30



## Unpacking and checking

- Cut the straps with a pair of scissors and lift the carton straight-up.
- Carefully lift the SANOMAT out of the Styrofoam base and check the SANOMAT for shipping damage. If applicable submit a claim to the transport company.
- Check that you have received all of the following:
  - ✓ Operating instructions and shipping documents
  - ✓ Disinfection cleaner (0,25 l SANO-DESINFEKT-Plus)
  - ✓ Small bag with:
    - Socket Wrench
    - Jaw Wrench (only Model GPM/GPMA)
    - Pushing rod (plastic)
    - Cleaning Nozzle
    - 3 cleaning brushes
    - Set of gaskets
    - Vaseline



## Use according to determination of SANOMAT

- The SANOMAT has to be operated at an environmental temperature up to max. 40°C (104°F)
- The SANOMAT is a technical means of work. Its bringing into circulation serves **exclusively for the use in commercial business**.
- Do not run the SANOMAT in rooms with explosive atmosphere. The use of the SANOMAT according to determination is restricted to persons older than 14 years.



## Safety first!

To ensure safety and ongoing satisfaction with your SANOMAT, pay attention to the following regulations:



**Do not use SANOMAT for other purposes!**

Every attempt to do so can cause damage!



**When cleaning or repairing unit, use only original Vaihinger-SANOMAT Spare-Parts and Accessories!**

Using other parts can lead to damage! Also, this could cancel the warranty and the official approval of the cream machine.



**Never use hose or steam power washer to clean SANOMAT!**

Injury to people and damage to the unit can result if water gets into electric components!



**Only trained personnel should be allowed to operate the SANOMAT!**

Give your staff proper training. This manual will help you in this regard.



**The security of use and function has to be ensured by regular maintenance.**



**Follow operating instructions closely!**



**Install the SANOMAT in a way that the wall socket stays accessible (cut of power supply if necessary)!**



## Setting-up and connecting

- Ensure that the SANOMAT is standing with its 4 feet on a solid, flat and level surface. Pay particular attention to:
  - ⚠ **Fire danger due to heat build-up! Ensure minimum clearance of at least 5 cm (2") on both sides of the machine!**
  - ⚠ **Avoid exposure to direct sunlight!**
- Make sure that your socket is properly grounded and has got the right power supply:
  - 230V ~ / 50Hz **Fuse at least 10 A.**
  - 110-120V/60Hz **Fuse at least 15 A.**
  - 100V/50/60Hz **Fuse at least 15 A.**
- Remove any dust which may have come from packaging material. Plug in cord.

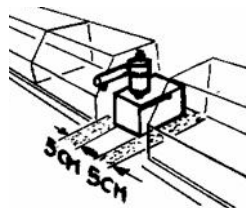

**⚠ Please carry out the daily disinfection cleaning before initial fill! (See page 13, Daily disinfection cleaning)**

⇒ Your SANOMAT is ready for use!



## Getting ready to start unit

- Turning lightly insert the Whipping System into the Valve Head and fix it by the Locking Device (fork). Turn and move the Whipping System back and forth until the Locking Device can be inserted all the way (fig. 1). (All models except „Mini-Bako-S top part with stand“: read further at **point 2**)

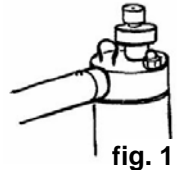

### **Model Mini-Bako-S top part with Stand:**

- Close the Reduction Valve in order to prevent cream flowing out the cream container (fig. a).
- Fill cream container with pre-refrigerated cream (+3°C to +5°C) and close container tightly with the cover.
- Place Cream Container onto the stand.  
**Please note: Connection for cream hose must be placed into the groove of the stand! (fig. b)**
- Insert the other side of the Reduction Valve into the bore hole of the Air Regulation (fig. c).

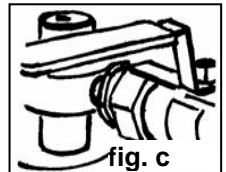
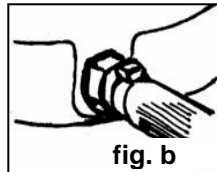
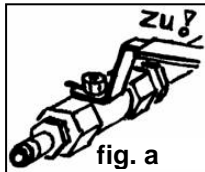
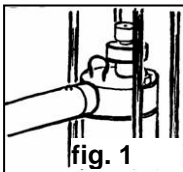

## bb. 1 Working with the Reduction Valve

### Pre-adjustment (machine is switched off)

- Open the reduction valve about 45° (fig. d).  
For cream with fat content of  
⇒ **less than 32 % close the** reduction valve a bit more  
⇒ **more than 32 % open the** reduction valve **somewhat**

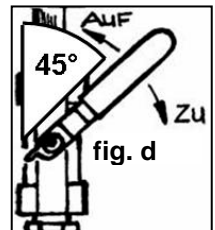

- Fine-adjustment (machine is switched on!)**

**Determine preferred consistency by trying different settings!  
Often, quite a small adjustment- less than 1 millimetre will suffice!**



**Please note:**

Prerequisite for a good whipping result is the exact adjustment of the Air Regulation (read further at „**Setting whipped cream consistency**“)

- Put the Suction Hose with the Suction Nozzle into the hole of the Air Regulation Case. (fig. 2)
- Put the Suction Hose with the Strainer into the container with the **refrigerated** liquid cream (between +3° and +5°C) (fig. 3)

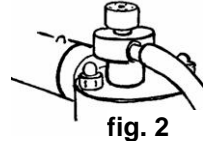

**⚠ Do not use icing sugar or regular sugars. May cause damage to pump through undissolved sugar-crystals!**

- If you wish to add sweetener, add sugar-syrup to the **cool** cream being still in its original packing and mix thoroughly (sugar-syrup with 75-80% sugar).
- Model “MA”:** Plug-in contact socket for automatic shut-off onto contact pin at suction hose (green light on).

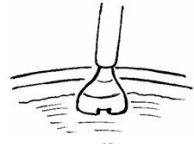





## Setting whipped cream consistency

**i** The adjustment of air regulation acts in accordance to the fat content of the used cream and the desired stability. Cream with a lower fat content than 30 % needs a higher air supply, whereas cream over 32 % needs a lower air supply.

- Turn Air Regulation Screw clockwise to "0" (=closed), then turn Air Regulation Screw back to desired position (numbers point to the outlet, see fig. 4).

→ Best results are achieved at settings "3" to "4". Determine preferred consistency by trying different settings.

→ Often, quite a small adjustment- less than 1 millimetre will suffice!

→ Using too much air causes sputtering or the cream is whipped too stable, respectively. the cream can turn into butter and the machine has to be completely cleaned!

→ Using too less air cream will be too soft or liquid.

→ Without air, cream will not get whipped, and the pump is being overworked unnecessarily. - Therefore:

**⚠ Do not leave Air Regulation Screw in position "0"**

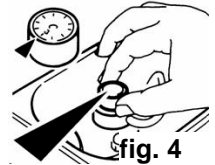



## **Selecting desired quantity of whipped cream**

You can dispense as much whipped cream as you just need by the Rocker Switch (**Model HAND**) respectively the Selector Button (**Model GP+GPM**).

- Press the Rocker Switch to „I“ respectively turn Selector Button to „I“. (fig. 5)
- ⇒ The SANOMAT will produce whipped cream until you press the Rocker Switch to „0“ again respectively until you turn the Selector Button to „0“ again.

**Modell HAND**

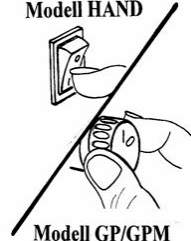

**Modell GP/GPM**

**fig. 5**

### **Model “MA”**

- Turn Selector Button to “I” (fig. 5a)
- ⇒ The SANOMAT will produce whipped cream until Selector Button position is reset to “0”.
- Turn Selector Button to “II”
- ⇒ The SANOMAT will produce whipped cream until Selector Button is released.



**fig. 5a**

### **Automatic “Shut-Off”:**

The SANOMAT will shut-off once there is no more cream in the container. Add cream, and the SANOMAT can again be used.



## ***Cleaning and maintenance (overview)***

Your SANOMAT should always operate trouble-free. In addition, it must always meet highest hygienic standards. Therefore:

** Pay close attention to cleaning and maintenance instructions!**

The summary below should help you in this regard:

<b>When</b>	<b>What</b>	<b>See</b>
Daily	Disinfection-Cleaning	from page 13 on
Monthly	Cleaning of Air Regulation	from page 16 on
Before extended shutdown	Disinfection Cleaning, Cleaning of Air Regulation	from page 13 on
After extended shutdown	Disinfection-Cleaning	from page 13 on
In case of trouble	Thorough Cleaning and Technical Check-Up	from page 17 on

And remember:

** When cleaning, use only original Vaihinger-SANOMAT supplies!**  
 Using other supplies can lead to equipment damage! Also, this could cancel the warranty and the official approval of the cream machine.

** Never use hose or steam power washer to clean SANOMAT!**  
 Injury to people and damage to the unit can result if water gets into electric components!



## Daily disinfection cleaning

If cream remnants are allowed to remain in the system, bacteria will quickly form!  
This results in:

- ⇒ poor quality of whipped cream and
- ⇒ health risks to clients! – Therefore:

**⚠ SANOMAT is to be cleaned according to these instructions at the end of each working day!**

**⚠ Never leave SANOMAT dirty overnight!**

**Caution: You can find the disinfection cleaning instructions for Model „GP/GPM“ from page 21 on!!!**

### Model Mini-Bako-S top part with Stand:

**If there is cream left in the cream container:**

- Close Reduction Valve and remove it from the Air Regulation.
- Clean the opening of the Reduction Valve with a paper towel.
- Lift cream container out of the stand.
- Store cream container and Reduction Valve in a refrigerator (between +3°C and +5°C).

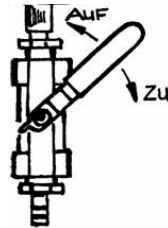

**If cream container is empty:**

- Open the Reduction Valve and put a 5-litre pail under the Outlet.
- Switch the machine on until the Suction Hose and Whipping Device are empty.
- Lift cream container out of the stand and open the cover.
- Clean cream container, cover and Reduction Valve under hot running water.
- Fill cream container with 1,5 l warm water (max 50°C (120°F)) and add 40 ml SANO-DESINFEKT-Plus.



*Tip: 40ml (1 ½ oz) = 4cl = 2 small glasses of 2cl*

**⚠ Do not fill the container with hot water!**



- Take Sanity Suction Hose (delivered together with the machine) and fix it to the machine.
- Put the Suction Hose with the Suction Nozzle into the flush container → read further at point 6

1. Put a 5-litre pail under the Outlet, lift the Suction Hose with the Strainer out of the liquid cream and clean its outside with a paper towel. **Model “MA”**: Remove contact socket for automatic shut-off from contact pin at suction hose. (fig. 6a)
2. Start the machine until the Suction Hose is completely emptied.
3. Fill cream container with 1,5 l warm water (max 50°C (120°F)) and plug in Suction Hose.



fig. 6a

**⚠ Do not use hot water!**

4. Press Rocker Switch/Selection Button / **Model “MA”**: Move Selector Button from “0” to “II” several times, until the water has run through (intermittent flushing, min. 36 times)
5. Replace Garnishing Nozzle with Cleaning Nozzle. (fig. 7).

**⚠ Never use Cleaning Nozzle with cream!**

6. Clean the Garnishing Nozzle under hot running water.
7. Fill cream container with 1,5 l warm water (max 50°C (120°F)) and add 40 ml SANO-DESINFEKT-Plus. (fig. 8)

*Tip: 40ml (1 ½ oz) = 4cl = 2 small glasses of 2cl*

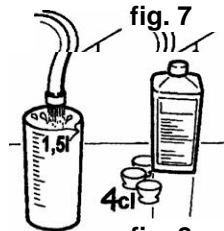

fig. 8

**⚠ Do not use or mix-in any other disinfectant agent!**

8. Press Rocker Switch/Selection Button / **Model “MA”**: Move Selector Button from “0” to “II” several times until the disinfection cleaner has all run through (intermittent flushing, min. 36 times)
9. Remove Cleaning Nozzle and Suction Hose and clean both under hot running water.
10. Fill Cleaning Container with 1,5 litres **cold** drinking water (**Model “MA”**: Connect it with the automatic shut off). Plug-in Suction Hose and Cleaning Nozzle.



11. Press Rocker Switch/Selection Button / “**Model “MA”**: Move Selector Button from “0” to “II” several times until the water has run through (intermittent flushing, min. 36 times).

12. Replace Cleaning Nozzle with Garnishing Nozzle! Soak a clean towel with disinfection cleaner and wipe the SANOMAT. (fig. 9)

13. Wipe SANOMAT with a dry towel.

⇒ The Disinfection Cleaning is now complete. Your SANOMAT can again be used.

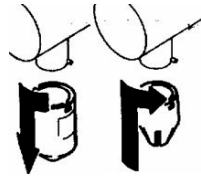

**fig. 9**



## Monthly cleaning of Air Regulation

### Disassembly

- Carry-out a complete Disinfection Cleaning.
- Remove Air Regulation Screw and Locking Device. (fig. 10). Pull-out Air Regulation Case.
- Push Locking Device from the bottom into the housing and remove the Non Return Valve and Air Nozzle Disc. (fig. 11).

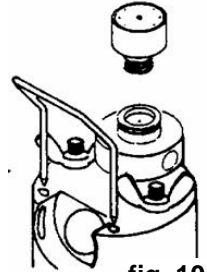

fig. 10

### Cleaning

- Clean the opening in the Air Nozzle Disc with the smallest brush (fig. 12)
- Clean all parts with SANO-DESINFEKT-Plus. Thoroughly rinse all parts with hot running water.

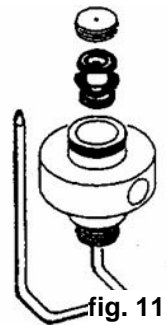

fig. 11

### Reassembly

- Turn the Air Regulation Case so that it clicks into proper position:

**⚠ The hole for Suction Hose goes to the right, not to the back! (fig. 13)**

- Re-install all other parts, including the Suction Hose.
- Close the Air Regulation Screw clockwise all the way (to position '0')
- Turn the Air Regulation Screw back to its normal position. Ready!

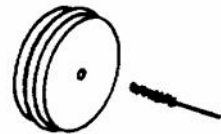

fig. 12



fig. 13



### Thorough Cleaning and Technical Check-Up

Provided all instructions are followed in detail, the SANOMAT will operate without problems for a long time.

Nevertheless, should problems occur, a thorough cleaning and check-up must be carried out. When this is done, all parts subject to wear and tear must be exchanged.

### Safety Regulation

The inadvertent start-up of a unit taken apart is always dangerous! Therefore:

**⚠ Before disassembling the unit, unplug power cord to prevent personnel injury and damage to the equipment!**

### Preparation

- Have all parts and tools ready, that are needed for the taking-apart, cleaning and reassembly:
  - a) Equipment Set supplied with the unit (or re-ordered)
  - b) Tools and cleaning brushes supplied with the unit
  - c) Cream container from the SANOMAT
  - d) Vaseline and a Paper clip
- When taking the unit apart, carefully place all small parts in the cream container.

**⚠ Losing a part results in downtime of the unit until a replacement can be obtained!**

- Conduct a proper Disinfection-Cleaning and cleaning of Air Regulation (see page 13), but:

**Do not reassemble the unit at this time!**

### Models HAND + GP

- Remove Garnishing Nozzle and Locking Device (fork) from Valve Head. Turning lightly, pull Whipping System out of the Valve Head. (fig. 14)
- Pull the Locking Device out of the Outlet Part and turning lightly pull-out the Whipping Pipe of the Outlet Part. (fig. 15)

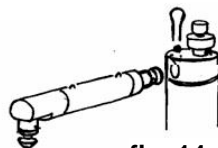

fig. 14

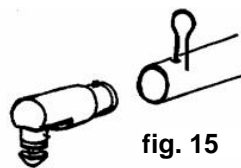

fig. 15

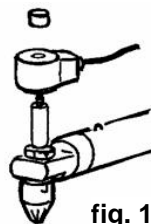

fig. 16





### Model GPM

- Remove Knurled Nut from Magnetic Valve, Lift-up the Magnet-Coil and let it hang by its cable. (fig. 16)
- With the wrench, unscrew the Upper Closing Unit and lift-out the Magnetic Core and spring. Remove Garnishing Nozzle. (fig. 17)

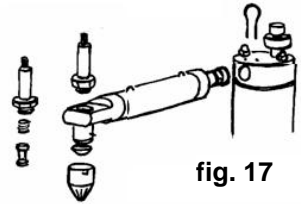

fig. 17

- Remove Locking Device from Valve Head. Turning lightly pull Cream Whipping Assembly out of its housing. (fig. 17)
- With the Locking Device, push in the Locking Bolt and with light turns, pull away the Outlet Part. (fig. 15)

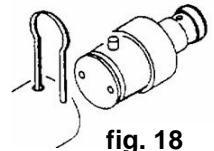

fig. 18

### All Models

- With the Locking Device, push in the other Locking Bolt and pull-out the Inlet Part. (fig. 18)
- Slide the Pushing Rod into the Whipping Pipe and push-out the Inlet Part, the 13 Whipping Discs and 12 Intermediate Discs (resp. the whole Whipping Column). (fig. 19)
- With the socket wrench remove the hexagon nuts from Valve Head and Lift-off Valve Head and Steering Disk and pull-out the pump. (fig. 20)



fig. 19

### Do not disassemble pump!

- Remove **all** O-Rings. For O-Rings on the inside, you should use the paperclip. Discard **all** removed O-Rings! (fig. 21)

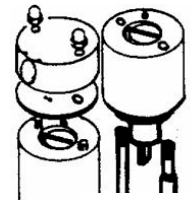

fig. 20

### Cleaning

- Put a fine sieve in the drain of the sink, to prevent losing a small part which

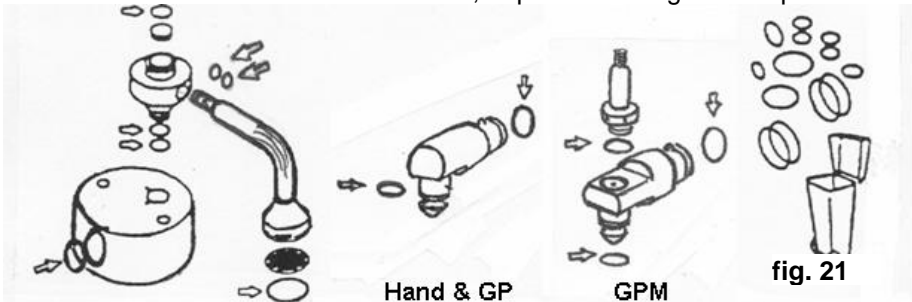

fig. 21



---

would result in downtime of the unit until a replacement can be obtained!

- Fill a bowl with hot water and add a few drops of SANO-DESINFEKT-Plus.

**⚠ Do not use any other cleaning agents!**

- Clean all parts in this solution.
- Clean all cavities thoroughly with the fitting brushes (Equipment Set)

**⚠ Do not use any cleaning tools that could leave scratches!**

- Clean the grooves for the O-Rings very thoroughly.
- Rinse pump very thoroughly while turning rotor. **Do not take the pump apart!**
- Rinse all parts once more with running hot water. Dry all parts with a lint-free cloth accurately.

### Testing

- Check that the Pump-Rotor turns easily and that all parts appear in good condition.
  - Exchange questionable parts by new ones!
- ➔ Poor or infrequent carrying-out of the Disinfection Cleaning could have resulted in corrosion on surfaces.

**Do not reinstall questionable parts!**

*If you are not sure:* Ask the after sale service of the manufacturer or your dealer!

- Put-on **all** new O-Rings and make sure, that the O-Rings fit properly! Lightly apply Vaseline to all new O-Rings.
  - **⚠ One missing or poorly placed O-Ring can lead to a leak or malfunction!**
  - Turning lightly install the pump until it catches (locking pin!). It must sit on the Gasket Disc at the bottom of the container. Install Valve Head. (fig. 20, page 18)
  - Hold the Whipping Pipe in vertical position (the side with the gasket on top) and insert the Pushing Rod from the bottom. Insert a Whipping Disc, add an Intermediate Disc (cone down). Alternating, add the remaining Whipping Discs (13 pcs.) and Intermediate Discs (12 pcs.), resp. insert the entire Whipping Column. (fig. 22)
  - Push the Outlet Part up to the stop onto the Whipping Pipe and push in Locking Device into the Outlet Part. (fig. 23)
- ⇒ Locking bolt must snap in!



- Turn the Outlet Part and Whipping Pipe upside-down, so that the Pushing Rod is on top and remove the pushing rod.
- Insert the Inlet Part into the Whipping Pipe. (fig. 24)
- Slide the Whipping Assembly into the housing, turning lightly. Turn and move the Whipping Pipe back and forth until the Locking Device can be inserted all the way. (fig. 25)
- Put on the hexagon nuts and tighten them alternately by hand.

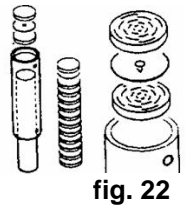

### Model GPM

- Place the spring and the Magnetic Core in the Upper Closing Unit and with the wrench screw the Upper Closing Unit onto the Outlet Part. (fig. 17, page 18)
- Place Magnet Coil and Knurled Nut on the Upper Closing Unit. (fig. 16, page 17) Tighten Knurled Nut.

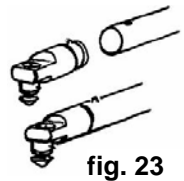

### All Models

- Slide on Garnishing Nozzle.
- Insert the Air Regulation Case, turning lightly until it locks into the correct position:

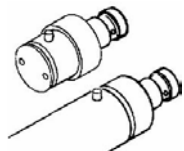

**⚠ The hole for Suction Hose goes to the right, not to the back!**

- Put-in the Non Return Valve and the Air Nozzle Disc. Put on the Air Regulation-Screw. (fig. 26)
- Turn Air Regulation-Screw in all the way and then back to its usual position.
- Put the Suction Hose with the Suction Nozzle into the hole of the Air regulation Case.

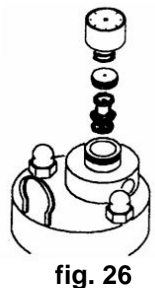
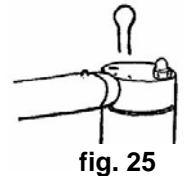

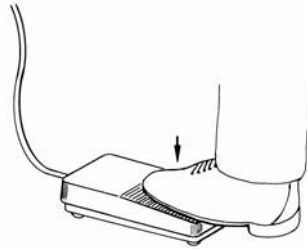
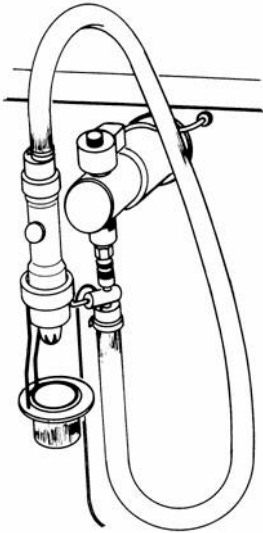

**SANOMAT**

**Garnishing pistol or foot switch**

**Operating instructions**

---

***Index***

Connection and operation of Garnishing Pistol/Foot Switch.....22

Daily Disinfection Cleaning of the Garnishing Pistol.....22



### **Connection of Garnishing Pistol or Foot Switch:**

- Plug in the plug into the socket of the machine (fig. 27).
- ⇒ Your SANOMAT is ready for operation by Foot Switch or Garnishing Pistol.

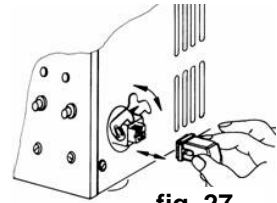

fig. 27

### **Operation by Foot Switch:**

- Press and hold foot switch (fig. 28).
- ⇒ The SANOMAT will produce whipped cream until Foot Switch will be released.

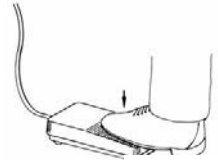

fig. 28

### **Operation by Garnishing Pistol:**

- Change the Garnishing Nozzle of the Machine by the connector of the Garnishing Pistol (fig. 29).
  - Take Garnishing Pistol out of the holder at the machine and press and hold operation key of the Garnishing Pistol.
- ⇒ The SANOMAT will produce whipped cream until operation key will be released.

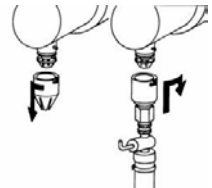

fig. 29

## ***Daily Disinfection Cleaning of the Garnishing Pistol***

**⚠ SANOMAT is to be cleaned according to these instructions at the end of each working day!**

**⚠ Never leave SANOMAT dirty overnight!**

**⚠ Please note: When cleaning the Garnishing Pistol use exclusively the operation key of the Garnishing Pistol!!!**

- Prepare a 5-litre pail. Put a 5-litre pail under the Outlet, lift the Suction Hose with the Strainer out of the liquid cream and clean its outside with a paper towel.
- Take Garnishing Pistol out of the holder and hold it into the pail (fig. 30).
- Press and hold the Operation Key of the Garnishing pistol until Suction Hose is emptied. (fig. 31).
- Put Garnishing Pistol back into the holder.
- Remove the Suction Hose including Suction Nozzle from the Air Regulation and clean it under hot running water.

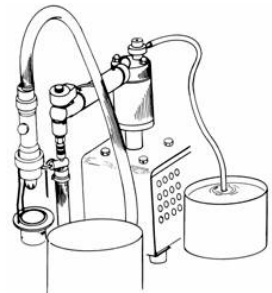

# SANOMAT

## Cream machines



- Fill cream container with 1,5 l warm water (max 50°C (120°F)) and plug in Suction Hose.

**⚠ Do not use hot water!**

- Put Suction Hose into the Cleaning Container
- Take Garnishing Pistol out of the holder and hold it into the 5-litre pail. Press Operation Key several times until the water has run through (intermittent flushing, min. 36 times).
- Fill cream container with 1,5 l warm water (max 50°C (120°F)) and add 40 ml SANO-DESINFEKT-Plus.

*Tip: 40ml (1 ½ oz) = 4cl = 2 small glasses of 2cl*

**⚠ Do not use or mix-in any other disinfectant agent!**

- Press Operation Key of Garnishing Pistol several times until the disinfection cleaner has run through (intermittent flushing, min. 36 times).

**⚠ This procedure must take at least 2 minutes!**

- Remove Suction Hose from the SANOMAT. Wash it under hot running water.
- Fill cream container with 1,5 l cold drinking-water. Plug-in Suction Hose.
- Press Operation Key several times until the water has run through (intermittent flushing, min. 36 times).
- Soak a clean towel with disinfection cleaner and wipe the the SANOMAT, the Garnishing Pistol, the drip pan and the tube of the Garnishing Pistol.
- Wipe SANOMAT and cream container with a dry towel and put cover back on.
  - ✓ The Disinfection Cleaning is now complete. Your SANOMAT can again be used

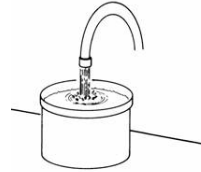

fig. 30



fig. 31



## ***Troubleshooting***

The pump is running, but no whipped cream comes out.	
Is the cream container empty?	Put cream into the container!
Are the nuts on the Valve Head loose?	Alternately tighten nuts!
Is the Magnetic Valve cleaved?	Carry-out a thorough cleaning and disinfection cleaning
Is there whipped cream in the Cream Container inside of the SANOMAT?	Remove cream. Carry-out Disinfection Cleaning.
The pump is dry	Give some liquid through the opening of Valve Head to Air Regulation
The whipped cream is not perfect or not stable	
Was the cream frozen or too warm?	Fill in new cream with a temperature about +3°C and +5°C (35-40°F)! Air Regulation is blocked! Disassemble valve into 3 parts and clean it.
After some time, did the cream settle?	Stir cream well!
Is the cream too sweet?	Remove cream! Prepare and add fresh cream!
Is homogenised cream ("UHT-cream") used?	Try a different sort!
Wasn't the SANOMAT cleaned properly?	Carry-out Disinfection Cleaning



## Shipping Information

If you need to move the SANOMAT to a different location, or want to leave it with someone else, the following is very important:

- **Pass along operating instructions and all supplies and parts that came with the unit!**

## Disposal Instructions

 **Never put machine into household garbage!**

The manufacturer will take back your old cream machine and dispose it according to the regulations!

## Technical Data

Model:

SANOMAT-Mini-Bako-S, SANOMAT-Mini-Bako-S-GP, SANOMAT-Mini-Bako-S-GPM, SANOMAT-Mini-Bako-S top part with Stand

Dimensions without Outlet (WxDxH) .....	20cm x 30cm x 45(62)cm
Weight .....	ca. 18 kg
Weight incl. top part .....	ca. 21,5 kg
Power .....	230V ~/ 50Hz
Power consumption (total) .....	600W
Power consumption (Pump Motor) .....	600W
Fuse .....	min. 10A
Noise level (may vary at different workplaces) .....	<70dB (A)
Electrical protection class .....	IP X1
Power .....	110/120V/60Hz
Power .....	100V/50/60Hz
Fuse .....	min. 15A





## Spare Parts

Please note: Above numbers of drawings are not order numbers!

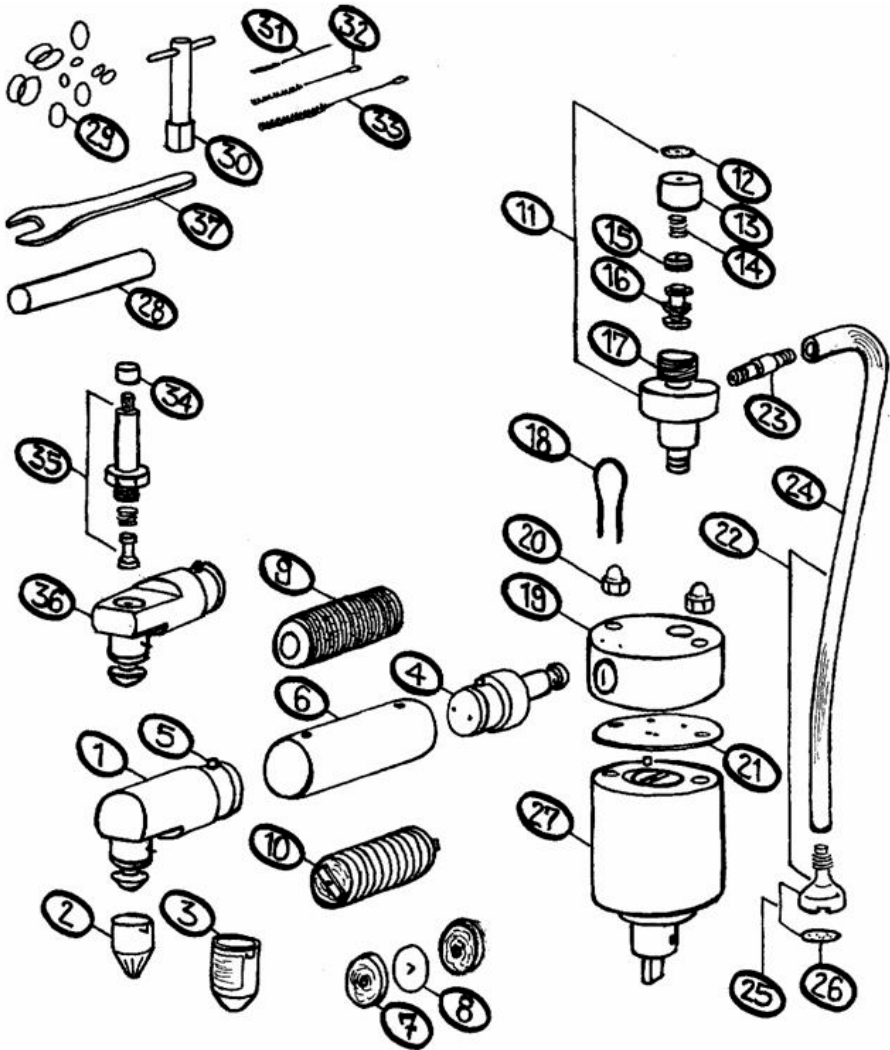



## Order Numbers

<b>Models HAND and GP</b>		
<b>Diagram</b>	<b>Order Numbers</b>	<b>Description</b>
1	X-ASM-006	Outlet Part mounted
2	30 139	Garnishing Pistol
3	X-RDM-001	Cleaning Nozzle
4	X-ESM-004	Inlet Part mounted
5	X-ARB-001	Locking bBolt
6	40 019	Whipping Pipe
7	35 003	Whipping Disc (13 Pcs.)
8	30 001	INtermediate Disc (12 Pcs.)
9	40 049	Whipping Column(Alternative for 30001+35003)
10	X-STW-001	Whipping Disc Column (Alternative for 30001+35003)
11	X-LRM-004-1	Air Regulation mounted
12	33 098	Scale for Air Regulation Screw Settings 0-6, blue
13	X-LRS-002	Air Regulation Screw mounted
14	11 007	Pressure Spring
15	40 169-1	Air Nozzle Disc
16	X-RVL-004	Non Return Valve
17	X-LRG-003	Air Regulation Case
18	11 051	Locking Device (fork)
19	X-VKM-006	Valve Head
20	10 028	Hexagon Nut
21	14 017	Steering Disc green
22	X-SSM-002	Suction Hose mounted
23	40 025	Suction Nozzle
24	12 006	Suction Hose 0,7m
25	X-SKM-002	Strainer
26	39 003	Sieve
27	X-PUM-005-2	Pump mounted
28	35 004	Pushing Rod <span style="float: right;">Tool</span>
29	51 003	Set of Gaskets
30	34 023	Socket Wrench <span style="float: right;">Tool</span>
31	34 036	Cleaning Brush (mini) <span style="float: right;">Tool</span>
32	34 003	Cleaning Brush (small) <span style="float: right;">Tool</span>
33	34 004	Cleaning Brush (medium) <span style="float: right;">Tool</span>
<b>Model GPM</b>		
<b>Diagram</b>	<b>Order Numbers</b>	<b>Description</b>
34	40 007	Knurled Nut
35	38 000-1	Upper Closing Unit
36	X-ASM-005	Outlet Part mounted
37	34 002	Jaw Wrench
<b>All other Spare Parts are identical with Models HAND and GP</b>		



## Spare Parts

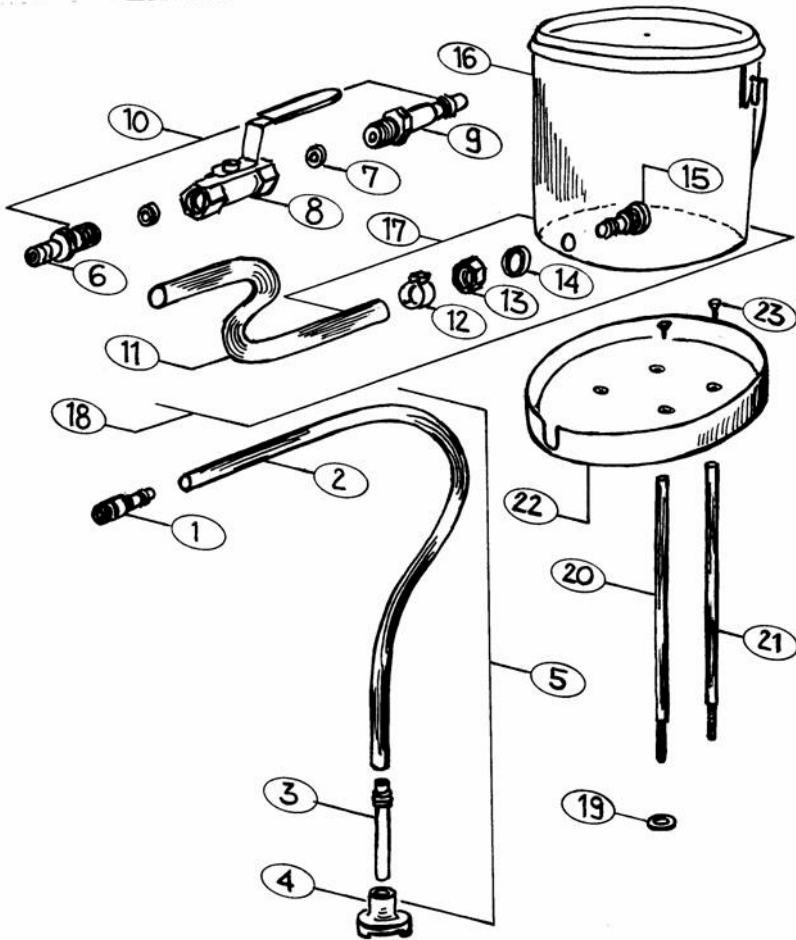

**Please note: Above numbers of drawings are not order numbers!**



## Order Numbers

<b>Model Mini-Bako-S top part with stand</b>		
<b>Diagram</b>	<b>Order Numbers</b>	<b>Description</b>
1	40141	Suction Nozzle
2	12006	Suction Hose (6x2)
3	40052	Adapter for Suction Hose
4	X-SKM-004	Strainer
5	X-SSM-003	Suction Hose mounted
6	40077	Valve Head Connection
7	11034	Gasket (2x)
8	39001	Reduction Valve
9	40078	Valve Head Connection
10	X-DRV-001	Reduction Valve mounted
11	12010	Suction Hose (9x2)
12	21012	Clamp
13	40030	Nut for Cream Container
14	40029	Washer (Cream Container)
15	40031	Connection for Cream Container
16	35006	Cream Container 5 ltr.plastic with Cover
17	X-SAT-002	Cream Conatiner 5-ltr. mounted
18	X-SAT-003	Cream Container with Reduction Valve mounted
19	10059	Disc
20	40028	Back stand
21	40074	Front stand
22	30004	Plate for Stand
23	10009-1	Screw 4x10

**All other Spare Parts are identical with Models HAND and GP**

**Note: When ordering, please give order numbers!!!**

## Spare Parts Model „GPMA“

<b>Model GPMA</b>		
<b>Diagram</b>	<b>Order Numbers</b>	<b>Description</b>
38	40216	Strainer
39	12013	Suction Hose
40	X-STM-002	Suction Nozzle mounted
41	X-SSM-008	Suction Hose mounted

**All other Spare Parts are identical with Model GPM**

**Note: When ordering, please give order numbers!!!**

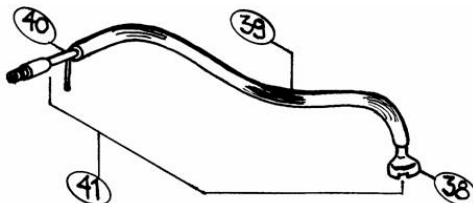



### Declaration of Conformity

The Vaihinger Cream Machine SANOMAT-Mini-Bako-S/-GP/-GPM-top part with stand is designed for the production of whipped cream in commercial enterprises.

The manufacturer declares, that this Cream Machine was designed, manufactured and documented according to the specifications, guidelines, regulations and conditions contained in the following:

2006/42/EC Machinery Directive

2014/35/EU Electrical equipment designed for use within certain voltage limits

2014/30/EU Electromagnetic Compatibility (EMC)

EC No 1935/2004 on materials and articles intended to come into contact with food

EU No 10/2011 on plastic materials and articles intended to come into contact with food

DIN EN 60204-1:2007-06 Safety of machinery - Electrical equipment of machines - Part 1: General requirements

DIN EN 55014-1:2012-05 EMC Requirements for household appliances, electric tools and similar apparatus. Emission

DIN EN 55014-2:2009-06 EMC Requirements for household appliances, electric tools and similar apparatus. Immunity

DIN EN 61000-3-2:2010-03 EMC Limits. Limits for harmonic current emissions

DIN EN 61000-3-3:2014-03 EMC. Limits. Limitation of voltage changes, voltage fluctuations and flicker

DIN EN 82079 Preparation of instructions for use. Structuring, content and presentation.

VDI 4500 Technical Documentation

GPSG Equipment and Product Safety Act

Vaihinger GmbH

Horstweg 29

D - 65520 Bad Camberg-Erbach

Phone: 0049 / 64 34 / 94 05 - 0

Fax: 0049 / 64 34 / 94 05 - 99

<http://www.vaihinger.com>

[info@vaihinger.com](mailto:info@vaihinger.com)



04/2016

Bernd Rehbein

Manager

© 05/2015 Vaihinger

Printed in Germany





---

**NOTES**

---

**Machine type:**

---

**Machine no°:**

---

**Date of purchase:**

---

**Retailer:**

---

**Invoice no°:**

---



---



---



---



---



---



---



---



---



---



---



---



---



---



---



---



---



---



---



---



---